



ABOUT

Self taught Designer & 3D Visualizer from Rajkot, Gujarat. I Began my journey as a 3D Visualizer working with product design companies and have since moved on to working as a freelance Interior and Architectural 3D Visualizer. I also have a keen interest in product design and development and have work experience in the same.

PROFICIENCY

CAD

(Design & Drafting)

3D Visualization

(Architectural & Product)

3D Animation

(Product Installation /
Demonstration / Assembly)

Graphic Design

SOFTWARES

Solid EDGE / SolidWorks

Ansys

Blender 3D

3DS Max + Corona Renderer

Keyshot 3D

Adobe Illustrator

Adobe After Effects

CONTACT

✉ rohinak2003@gmail.com

☎ +91 7487892288

DESIGN | VISUALIZATION

ROHIN KHAMBHAYATA

WORK EXPERIENCE

FREELANCING | 5+ YEARS | 20+ CLIENTS

3D VISUALIZER/DESIGNER

2021 - 2025

Spitze by Everyday, Gujarat

- 3D Rendering for kitchen hardware products such as Handles, Knobs, Metal Profiles, Vertical/Corner Storage, etc for brochures and website.
- 3D animated demonstrative installation videos for various products.
- Product design for wooden door handles.

3D VISUALIZER

2021 - 2023

D'Era Curtains, Gujarat

- Photorealistic 3D Mockups to visualize curtain design and detail for brochures and website
- 3D Visualization for wallpapers as well.

ARCHITECTURAL 3D VISUALIZER

2022 - current

Freelance

- 3D Visualization for Interiors as well as exteriors.
- Still renders & 360° renders
- 10+ Clients & 35+ Projects

EDUCATION

AVPTI, RAJKOT

2020 - 2023

Diploma - E&C Engineering

BVDU, PUNE

2024 - 2027

B.tech - Robotics & Automation Engineering

DESIGN / CAD WORK

FSAE Supra - Front Wheel Assembly

2025

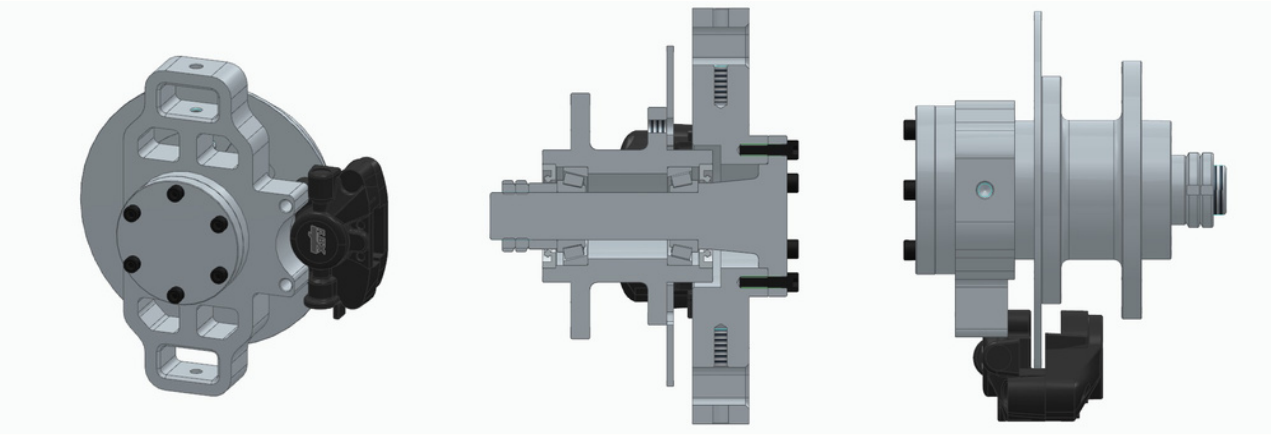

Norton Gearbox for Lathe

2022

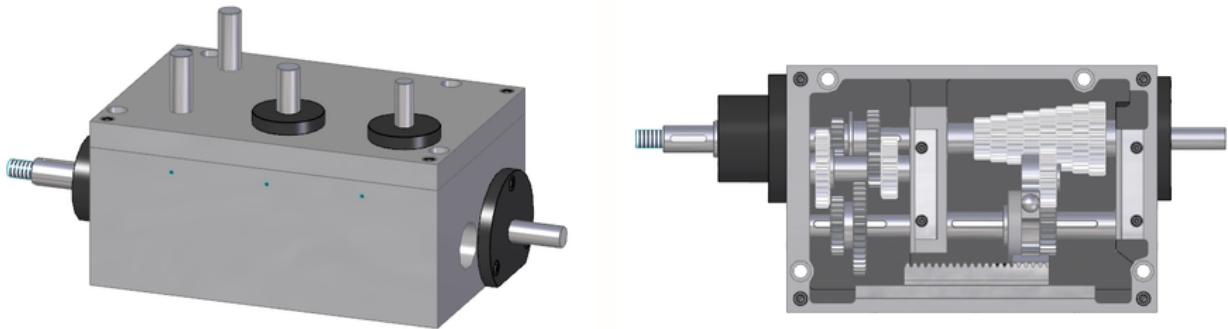

Orbital Gearbox for Concrete Mixer

2024

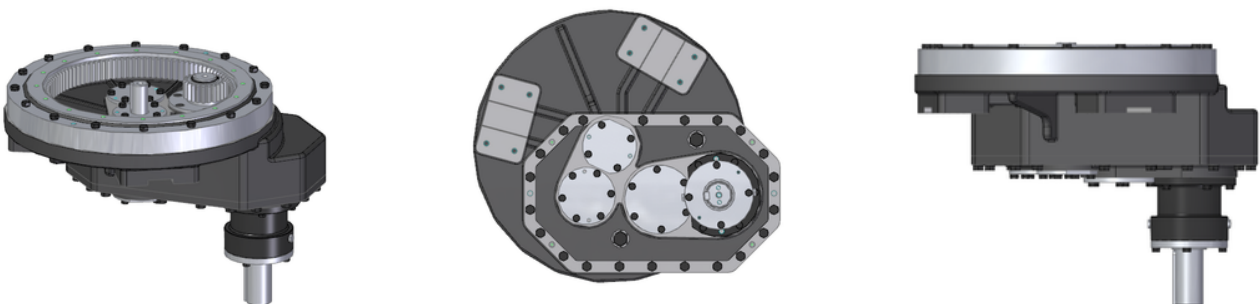

DESIGN / CAD WORK

Welding fixture

2020

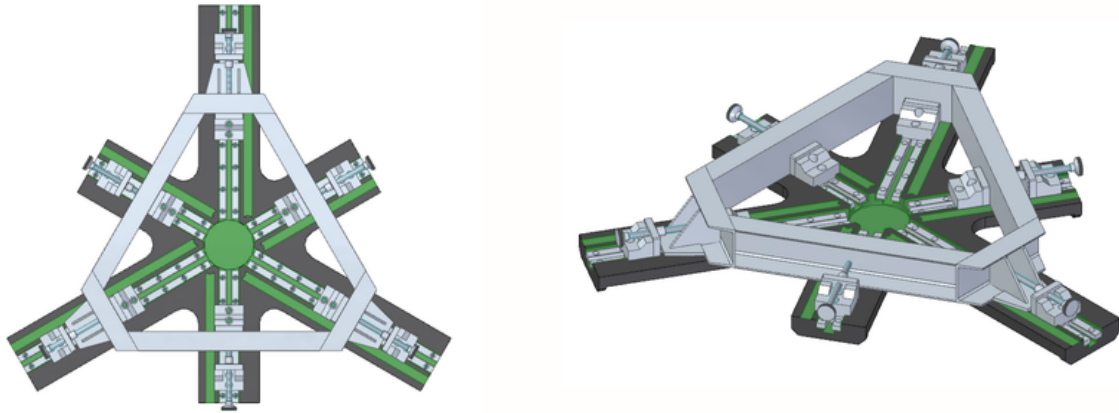

UV Disinfection equipment

2020

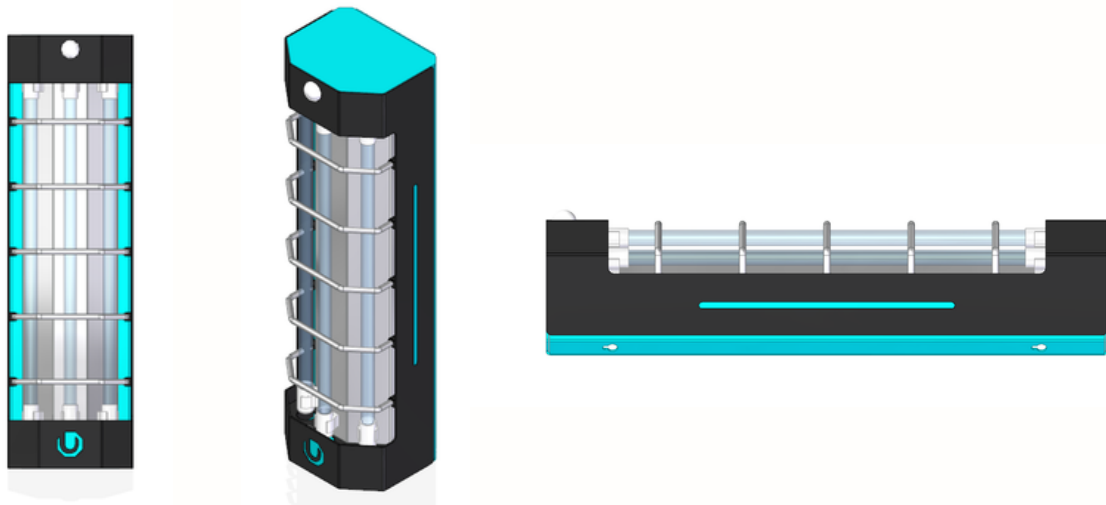

3D RENDERING / ANIMATION WORK

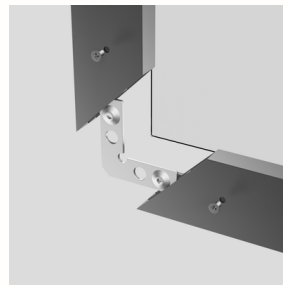
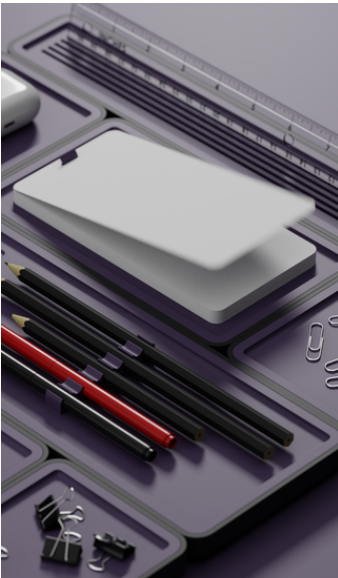

Scan for Full
Portfolio and
Animations

